

DETAIL 1

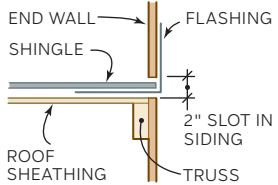

DETAIL 2

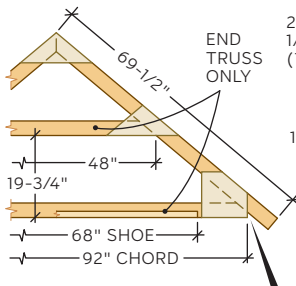

DETAIL 3

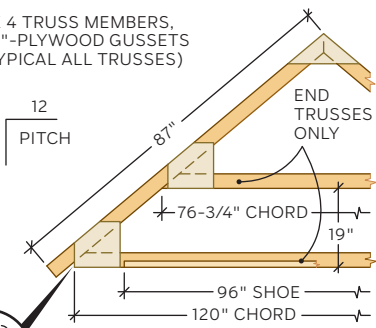

DETAIL 4

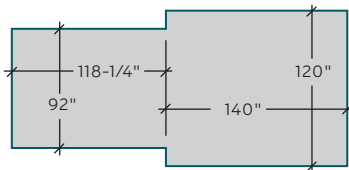
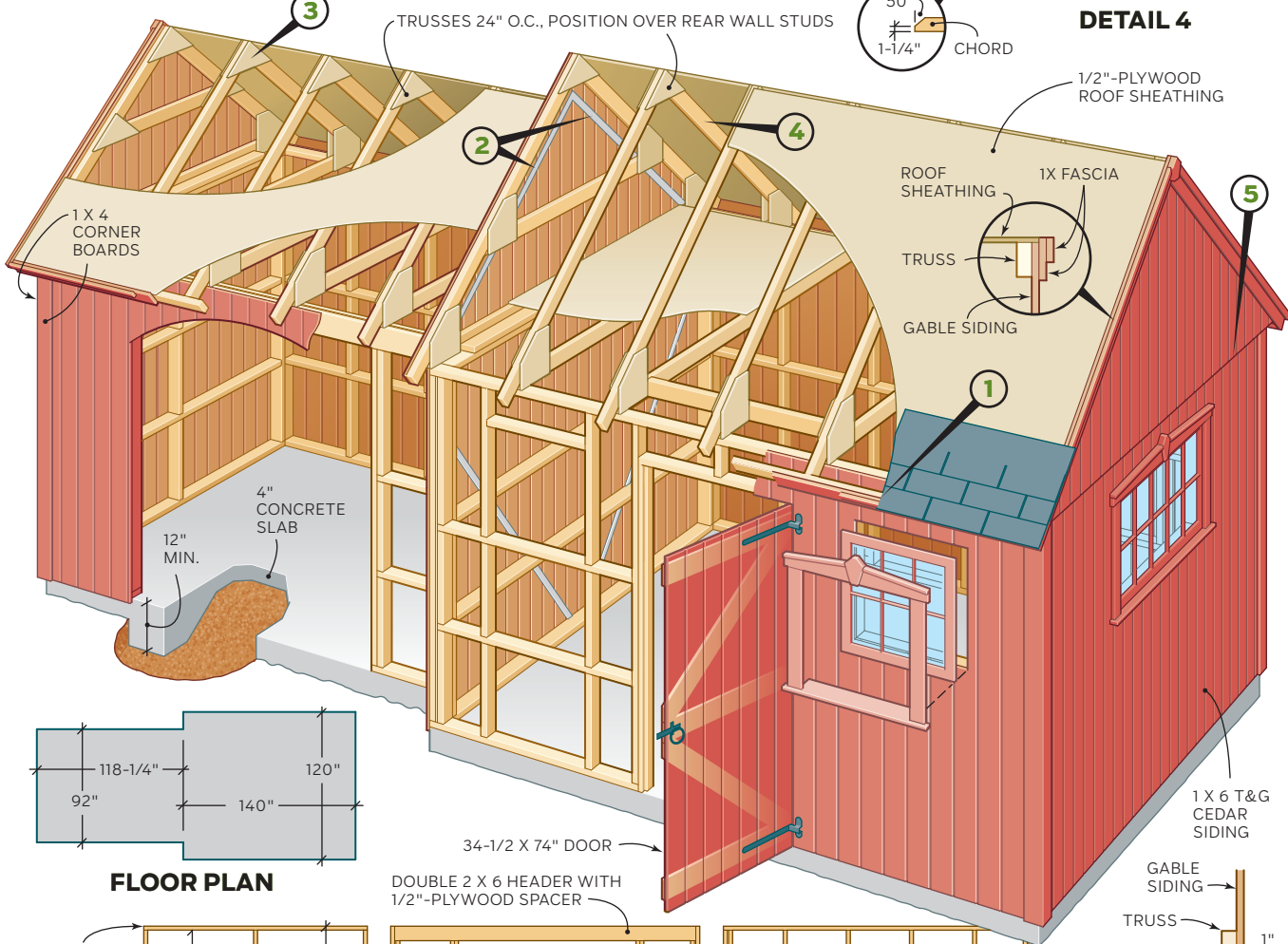

FLOOR PLAN

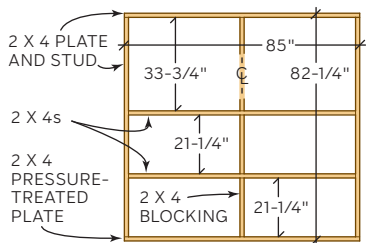

LEFT WALL

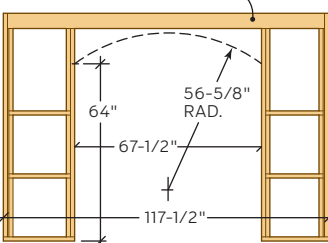

FRONT WALL

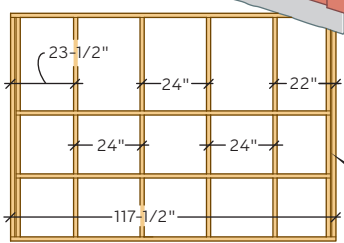

REAR WALL

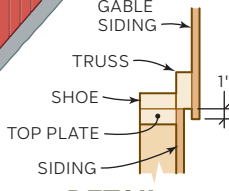

DETAIL 5

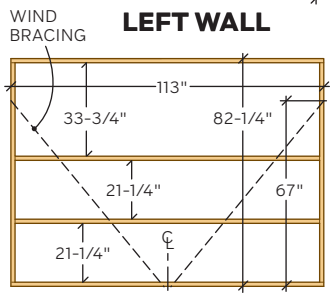

LEFT WALL

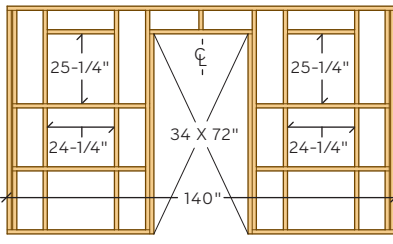

FRONT WALL

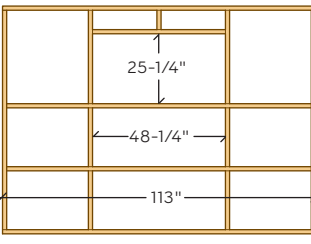

RIGHT WALL

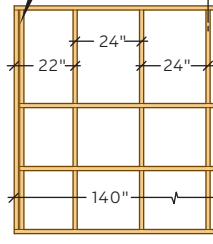

REAR WALL

For More Details & Instructions, check out:

Ryan Shed Plans



You'll get full access to the complete plans,
instructions and drawings

[Click Here To Get Access Now](#)